



Instruction Manual

for

Temperature Controlled Soldering Station

LF-1600

For Lead-free soldering application and rework on professional SMD electronics.

INTRODUCTION

Thank you for purchasing Xytronic's high power soldering station – the best solution for your soldering equipment needs especially for lead free applications! We believe that you will be more than satisfied with many features and the versatility of your new soldering station. **Please carefully** read the instruction manual prior to operate to maximize the advantages of using your new soldering station.

 **WARNING:** This appliance is not intended for use by children or other persons without assistance or supervision if their physical, sensory or mental capabilities prevent them from using it safely. Children should be supervised to ensure that they do not play with the appliance. Failure to observe the safety regulation will result in a risk to life and limb. The manufacturer shall not be liable for damage resulting from misuse of the unit or unauthorized alterations.

 **CAUTION:**

- ◆ Always place the soldering iron in its original holder when not being used.
- ◆ Keep the soldering tip and heating element away from the body, clothes and flammable material when in operation.
- ◆ The soldering tip and the heating element are still remaining hot after being switched off. Ensure that you do not touch the soldering tip and the heating element.
- ◆ For your health, do not inhale solder fumes.
- ◆ You must not undertake work on live parts. Only the technician is permitted to undertake repairs. Use the original replacement part only.

KEY FEATURES

- ◆ **HEATER/SENSOR FAILED DETECTION:** If sensor circuit failed that the display read “S--E” and cut off the heater power. If heater circuit failed the display read “H--E” and cut off the heater power.
- ◆ **TEMPERATURE “LOCK-OUT” FEATURE:** The temperature can be locked by “password” code that is convenient for production line management.
- ◆ **ISOLATED IRON HOLDER WITH TIP CLEANER:** Made of low abrasive brass shavings instead of conventional sponges to meet RoHS requirement cleans better and no water is necessary.
- ◆ **LOW VOLTAGE OUTPUT WITH SAFETY OPERATION:** The power unit is isolated from the A.C. line by a transformer and allows 32Vac to drive the heating element. Solder wand runs from 32 Volts for safety and with 80W power ceramic heater for a super-fast heat-up and quick temperature recovery. The solder wand is attached with heat resistant, non-burning, flexible 5-wire cord.

- ◆ **ESD SAFE AND SPIKE FREE CIRCUITRY:** The “Zero Voltage” electronic switching design also protects voltage and current sensitive components (CMOS devices, etc.) against damaging current and transient voltage spikes commonly produced by less efficient, mechanically switched stations.
- ◆ **DETACHABLE AC POWER CORD WITH PLUG:** Engineered AC outlet for alternating AC power cord with plug and connector specially designed for individual CE countries requirements.
- ◆ **EARTH JACK:** With a grounding connector, there is the possibility for a grounding of the wire strap if required.
- ◆ **OPTIONAL SMD TWEEZERS :** The additional feature is specially designed for SMD chips, SOT, Flat pack ICs’ etc. reworking. TWZ80 Tweezers is equipped with 32V/40W* 2 heaters which can be interchangeable with solder wand as an option. Be sure before proceeding this operation, the main switch must be “OFF” to avoid any damage to the unit.

PRODUCT DESCRIPTION

LF-1600 electronically temperature controlled soldering station with specially intelligent chip microcomputer control designs was developed to meet the present and future Lead-free soldering needs of the electronic production industry and suitable for work on professional SMD electronics. An ergonomic handle with shorter distance between heating element and tip gets very fast heat up time and quick heat compensation. A high-quality sensor and heat transfer technology ensure precise temperature regulation is essential for making consistent, reliable soldered connections. The aluminum housing has the advantages of strong structure, good heat sink and effectively resistant of electro-magnetic interference. It provides all the benefits of temperature regulation and connects via a highly flexible burn-resistant lead, and can be easily adjusted in temperature.

The LF-1600 incorporates electronic circuitry which enables the user to alter tip temperature from 200 to 480°C (392-896°F) without changing tips or heating elements. Also, with digital display readout and pressing keys on the front panel get clear vision and comfortable setting. The temperature is maintained within +/-3°C (+/- 6°F) of its operating temperature by a thermocouple sensor placed in the head of the heating element, allowing the tip to rest against the sensor. The 80W power results in both a rapid heat-up and super fast recovery.

The revolutionary “Zero Voltage” electronic switching design also protects voltage and current sensitive components (CMOS devices. etc.) against damaging current and

transient voltage spikes commonly produced by less efficient, mechanically switched stations. The power unit is isolated from the A.C. line by a transformer and allows only 32Vac to drive the heating element. The temperature “Lock-out” feature by “password” is convenient for production management. The many features of the product make it the ideal tool for service and repair technicians as well as production line soldering operations. This unit is developed to meet the present and future lead-free soldering needs of the electronic production industry and is ideal for use at any AC outlet.

BRIEF INTRODUCTION OF PANEL FUNCTIONS:

Front panel

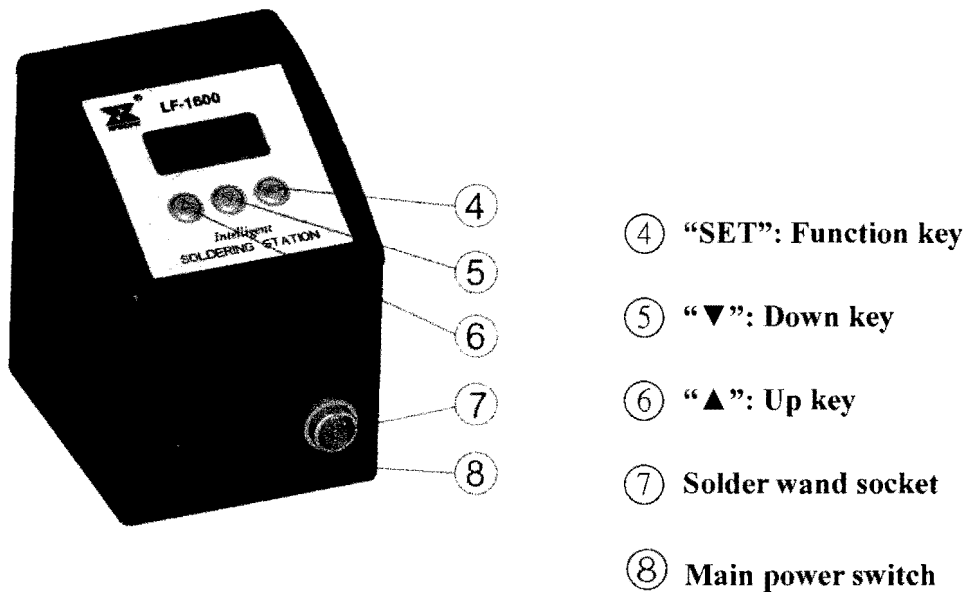
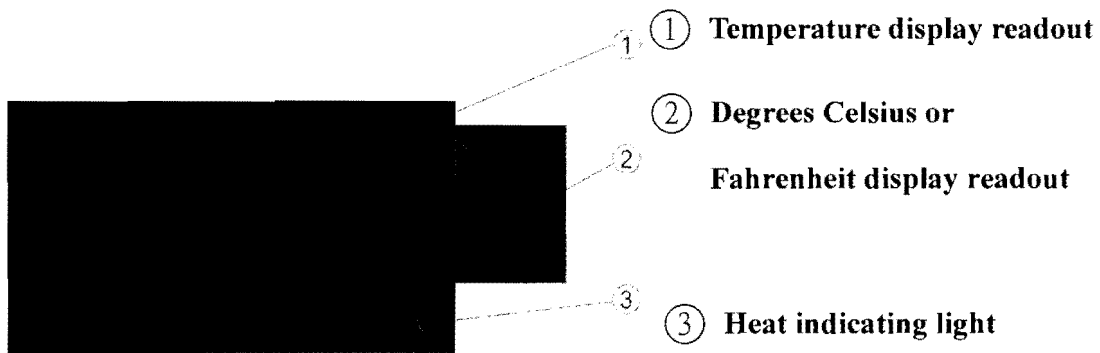

Rear side

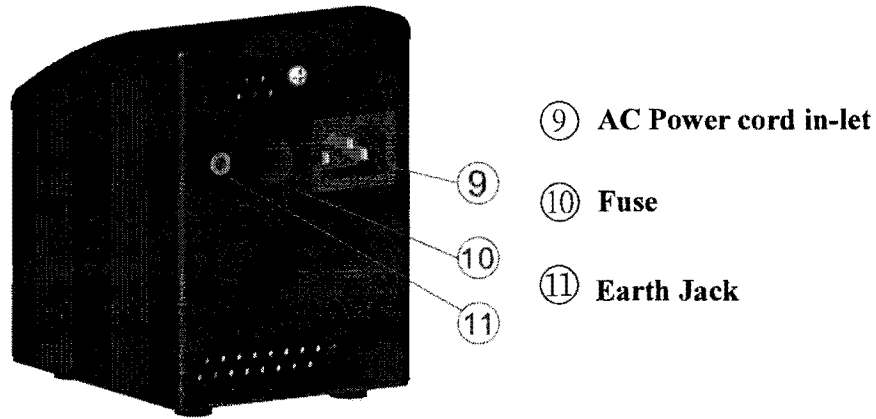
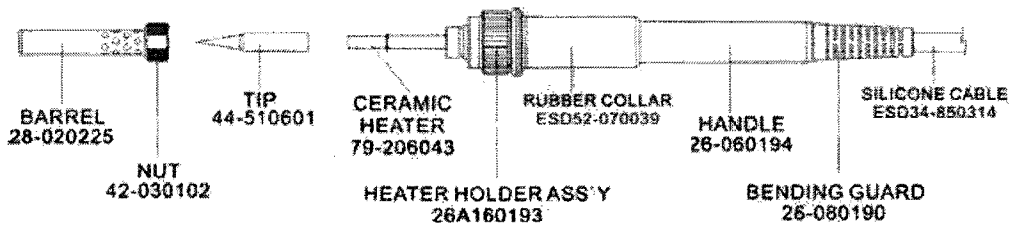

Fig. 1 Soldering iron assembly 108ESD



SPECIFICATIONS:

Model	LF-1600	
Input	220-240Vac 50Hz	100-120Vac 60Hz
Output	32Vac/80W	
Fuse (Slow type)	T1A	T2A
Temperature Range	200°C-480°C (392°F-896°F)	
Temperature Correction Range	+99°C~-99°C/+210°F~-210°F	
Default Set	200°C/392°F	
	Temperature correction value“00”	
Figure Dimension	105 x 90 x 126mm (W x H x D)	
Weight (Unit only)	1.5kg	

WORKING TEMPERATURE

To meet RoHS requirements, the 60/40 solder alloys are not allowed in the production process. The lead free solder alloys require a working temperature of 30°C (54°F) higher than previous generation electrical soldering. The working temperature of solder is detailed below and can vary from manufacture to manufacture.

Melting point	220°C (428°F)
Normal operation	300-360°C (572-680°F)
Production line operation	360-410°C (680-770°F)

When the iron's working temperature is set within the parameters suitable for the type of solder being used, a good joint is assured. Too low of a temperature will slow the rate of solder flow while a high temperature setting might burn the flux in the solder and emit a heavy, white smoke resulting in a dry joint or permanent damage to the printed circuit board (P.C.B.) and may also shorten the tip life.

IMPORTANT: The temperature above 410°C (770°F) is not recommended for normal soldering functions, but can be used for short periods of time when high temperatures are required. **Please note** that the lead free solder alloys require a higher soldering temperature which shortens tip life.

OPERATING INSTRUCTIONS

- Ensure that the working voltage matches your power supply before beginning use.
- Check carefully for any damage during transportation.
- This unit contains:
 1. Solder wand.
 2. Iron holder with brass tip cleaner.
 3. AC power cord with plug.

OPERATING PROCEDURES:

1. Ensure that the base unit power switch is in the "OFF" position.
2. Plug in Solder wand and connect AC power cord to mains "In-let".
3. Turn "Mains power switch" to "ON" position.
4. Press the "▲" key up until the temperature to 250°C (482°F) (If set to degrees Centigrade, the temperature display window of the upper right corner shows °C, if set to degrees Fahrenheit, the temperature display window of the upper right corner shows °F). Then tin the surface of the tip by applying a new covering of solder after being warmed to protect tip and extend its life.
5. When the temperature reaches to the desired temperature that the heating indicator light will be flashed on and off to maintain the set temperature. The unit now is ready for use.

3. Password Setting:

When the LED displays "F-1" and flashes, press "SET" key one time and the unit enters the Password Set status. At this moment, the LED displays the pre-set value. Press "▲" or "▼" key to change password set value. If the user sets "000" that means the unit will be under the status of no password. If the user sets "100" then means the unit will be under the password status. Press "SET" key once to finish password setting and the unit will backup mode, the user can continue set other modes or back from the setting mode.

4. Temperature Correction Setting

Press "SET" key once when the LED displays "F-2" and flashes that the unit enters the Temperature Correction Mode. At this moment, the LED displays preset correction value.

A: Operation of Centigrade temperature correction (+99°C~-99°C)

Press "▲" or "▼" key to change the temperature correction value. The first digit "—" means minus (actual temperature is down), "No display" means plus (actual temperature is up).

B: Operation of Fahrenheit temperature correction value (+210°F~-210°F)

Press "▲" or "▼" key to change the temperature correction value. When the numbers is sparkling on LED displays, it means minus value (actual temperature is down), when the numbers stop sparkling, it means plus value (actual temperature is up). Press "SET" key once to finish the temperature correction and the unit automatically backup mode. The user may continue set other modes or back from the current setting mode.

Example for temperature correction: The current set temperature value is 200°C, however, the actual temperature is only 190°C. So it needs to correct by +10°C. Correction method: if the current correction value is 00 or -00; then change it to 10. If the current correction value is -20, then change it to -10. If the current correction value is 20, then change it to 30.

5. Fahrenheit and Centigrade (Celsius) temperature selection

When temperature display window shows "F-3" and blinking, press the "SET" button, at this time, the system enters the degrees Fahrenheit and Centigrade temperature selection function, indicating the temperature of the window shows the current status. Press "▲" or "▼" key to change the temperature selection status. It expressed as degrees Celsius temperature value If set to °C; it shows as degrees Fahrenheit temperature if set to °F

COMMON CAUSES OF TIP UNWETTING

1. Tip temperature higher than 410°C (770°F).
2. The tip working surfaces are not tinned while the iron idling.
3. Lack of flux in soldering, wicking, repairing, and touch-up operations.
4. Wiping the tip on a high sulfur content, dirty or dry sponges and rags.
5. Touching with organic substances such as plastic, resin, silicone, grease or other chemicals.
6. Impurities in solder and/or low tin content.

CARE OF TIPS

 **Caution:** The soldering iron can reach very high temperatures. Be sure to turn the unit off prior to carrying out any maintenance or trouble shooting steps listed below.

IMPORTANT

Remove the tip and clean after moderate to heavy use or at least daily for light usage. Remove any loose build up in the tip retaining assembly to prevent tip freezing.

The solder tips supplied are iron clad cooper and if used properly, they should maintain optimum life.

1. Always tin the tip before returning it to the holder, turning off the station, or storing it for long periods of time. Wipe the tip on a brass cleaner prior to use.
2. Keeping the iron set at high temperatures (more than 400°C or 750°F) will shorten tip life.
3. Does not use excessive pressure to the tip or rub the joint with the tip while soldering; it does not improve the heat transfer and may damage the tip.
4. Apply solder to the joint, not the tip when soldering. The flux is naturally caustic and thus will eat away the tip.
5. Never clean the tip with a file or abrasive materials.
6. Do not use fluxes which contain chloride or acid. Use only rosin or resin activated fluxes.
7. If an oxide film forms on the tip, it can be removed by careful buffing with a 600-800 grit emery cloth, isopropyl alcohol or equivalent and then wrapping rosin core solder around the newly exposed surfaces. Coat the tinned areas with rosin-core solder after the resin-core has melted.

NEW TIPS

Applying the following steps will lead to optimum life.

1. Set temperature to min. then turn the main power switch to the “ON” position.
2. Coat the tinned surfaces with rosin-core solder after reaching 250°C (482°F).
3. Set to desired temperature after allowing the unit to idle at 250°C for 3 minutes.
4. The iron will be ready for use once it reaches the preset temperature.

IMPORTANT: Remove and clean the tip daily. If a new tip is installed, remove any loose build up in the barrel assembly, otherwise the tip may fuse to the heating element or retaining barrel.

SMD TWEEZERS OPERATION

For optional TWZ80 SMD Tweezers operations:

- * Disconnect the soldering iron and change to TWZ80 Tweezers. Be sure the main power switch is “OFF” before preceding this operation to avoid any damage.
- * Use only the approximately designed tips for the job to avoid unnecessary component damage.
- * Gently pick up and remove components while ensuring that a vertical pick up and pull out motion is maintained.
- * Use the same procedure when reconnecting the solder wand.

Please note that the tweezers temperature will be lower about 50°C than the soldering iron temperature.

Fig. 2 Drawing of Tweezers & spares SMD tips for TWZ80

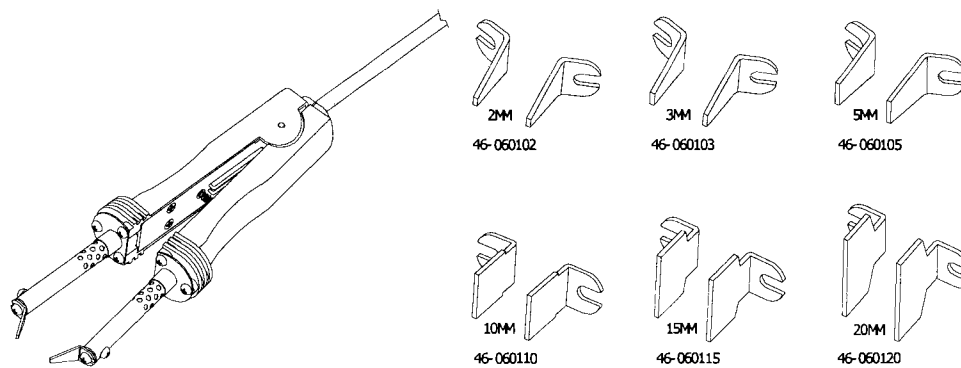

MAINTENANCE

TIP MAINTENANCE AND DRESSING

Tips can be changed or replaced simply by unscrewing the knurled nut barrel assembly. The station must be switched off and allowed to cool before this operation as damage may result if the system is left on without the tip in place!

After removing the tip, blow out any oxide dust that may have formed in the tip retaining area of the barrel. Be careful to avoid getting this dust in your eyes. Replace the tip and screw back the knurled nut barrel assembly using only firm hand pressure to tighten. Pliers should only be used to tighten the nut to avoid burning your fingers, but care should be taken not to over-tighten as this could damage the element.

GENERAL CLEANING

The outer cover of the iron and station may be cleaned with a damp cloth using small amounts of liquid detergent. Never submerge the unit in liquid or allow any liquid to enter the case of the station. Never use any solvent to clean the case.

SERVICE

If the iron or station should become faulty or, for some reason not operate normally, the system should be returned to the service department of your authorized dealer or service agent. Or a similarly qualified person in order to avoid a hazard.

INTERCHANGEABLE TIPS

